

NX-W5.2-LCR-P Video-Shielded Center/Left/Right In-Wall Home Theater Speaker System

Congratulations on choosing NXG In-Wall Loudspeakers. Like all NXG products, great care has been taken in their design. Their combination of advanced engineering and state-of-the-art materials will provide you with years of listening pleasure, while blending smoothly into your home's decor. Before you get started, it is a good idea to identify all the parts and hardware (See Fig. 1).

Where To Place Your In-Wall Speakers

Placement can make all the difference in how your speakers sound, and how easy they will be to install. Carefully consider where your speakers should be positioned. For optimum performance in a center-channel application, speaker should be mounted directly above or below TV or monitor. For optimum performance when used in right and left main listening positions, speakers should be mounted to the left and right of the main listening position and a minimum of 8 to 10 feet apart (See Fig. 2). Avoid mounting speakers in stud cavities containing electrical wiring, heating ducts, water pipes, etc. Make sure the wall or ceiling materials are sturdy enough to support the weight of the speakers.

Note: When the NX-W5.2-LCR-P is mounted horizontally in a center-channel application, modification may need to be made to the stud cavity to accommodate speaker.

Pivoting Tweeter (Fig. 3)

The tweeter in the NX-W5.2-LCR-P speaker may be adjusted, allowing you to tailor the speaker to better fit the listening area. The overall smoothest response is achieved with the tweeter facing straight out; however, you may find the sound more pleasing by aiming the tweeter toward a particular listening area. To adjust the tweeter angle, apply pressure on the ring surrounding the tweeter with your thumb or finger.

Tweeter Level Adjustments (Fig. 4)

The tweeter level control allows you to tailor the speakers' frequency response to better match the room's acoustics. As an example, if a room has a hardwood floor, which makes it acoustically brighter sounding, you may want to adjust the tweeter level down to compensate. You can experiment to find the sound that's most pleasing to you in your particular listening environment.

Speaker Installation In Existing Construction (See Fig. 5)

Once you have selected the location for your speakers, you are ready to install them.

You will need the following:

- Stud Finder
- Drill & Drill Bits
- Wire Cutter/Strippers
- Pencil
- Utility Knife or Drywall Saw
- Small Level
- Masking Tape
- Phillips Screwdriver
- Speaker Wire

NXG recommends the use of 16-gauge wire minimum. For wire options consult your retailer or custom audio contractor.

1. NXG Architectural Speakers are designed to be installed in the wall area between studs. Using a stud finder, make sure you are between two studs. Using the supplied template and a level to ensure your template is straight, tape the template to the wall and lightly trace around the inside with a pencil.

2. Cut the hole using your drywall saw. You may want to start with a small hole in the center of the outline. This will allow you to check for any obstructions that may exist behind the desired location. CAUTION: Be certain electrical wiring, water pipes or heating ducts do not interfere in the planned installation areas prior to drilling or cutting the wall.

3. Run speaker wire from your amplifier or speaker switching device to the speaker location.

4. Remove the grille from the speaker. If you like the standard white finish of your NXG In-Wall Speakers, skip to step 5, but if you want your speakers to blend in with a colored wall, now is the time to paint your speakers outer frames and perforated grilles. The speakers outer surfaces will accept ordinary latex wall paint or aerosol spray paint. Because the surface behind the grille should remain unpainted, you will need to cover this area. Cover the speaker's interior black surface, woofer and tweeter. Paint the outer speaker frame and grille separately.

5. Attach the wire to the input terminals on the rear of the speaker. Remember to maintain proper polarity with the amplifier by attaching the positive (+) lead to the red terminal and the negative (-) lead to the black terminal.

(Continued on reverse)

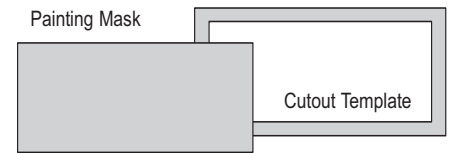
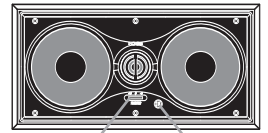

FIG. 1

Speaker with self-contained mounting clamps



Tweeter Level Switch

IR Sensor Knockout

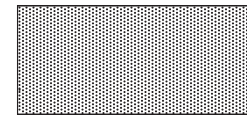

Aluminum Grille with foam inner backing

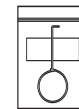

Grille removal tool



Black grille adhesive

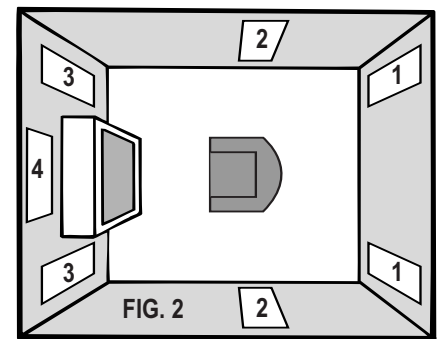
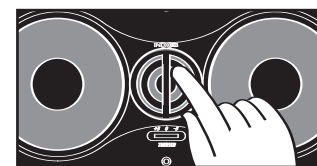

FIG. 2

NXG In-Wall Speakers can be used as rear surround sound channels by placing them (1) behind, (2) on each side of viewer, or (3) as front main home theater speakers. They also can be mounted horizontally for a center-channel application (4).



Press on the outer edge of the tweeter rim to rotate

FIG. 3



FIG. 4

Adjust tweeter level as shown

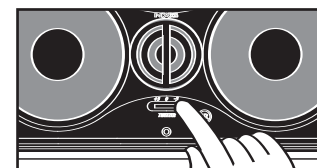

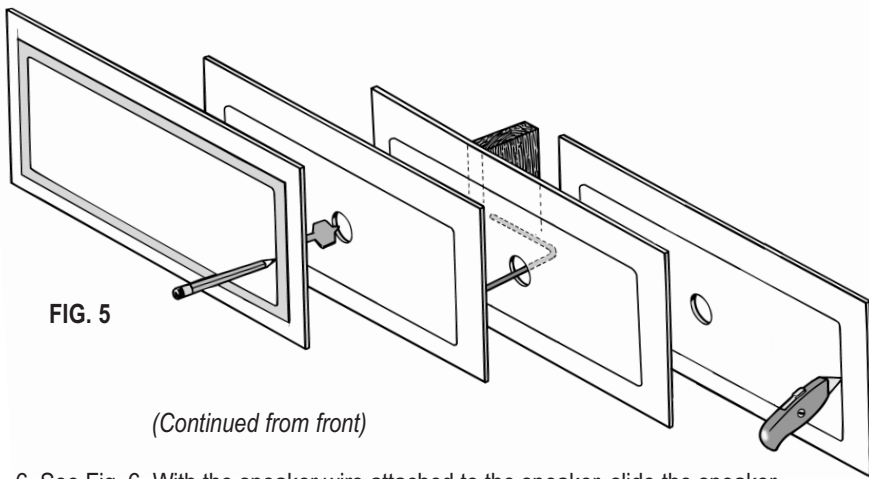

(Continued from front)

6. See Fig. 6. With the speaker wire attached to the speaker, slide the speaker up inside the cut-out hole. Center the speaker in the cut-out hole and turn the six locking screws clockwise until the speaker is drawn up snugly to the wall board from behind, clamping the speaker in place. Try to tighten each screw equally. Replace the speaker grill by gently pressing it into place.

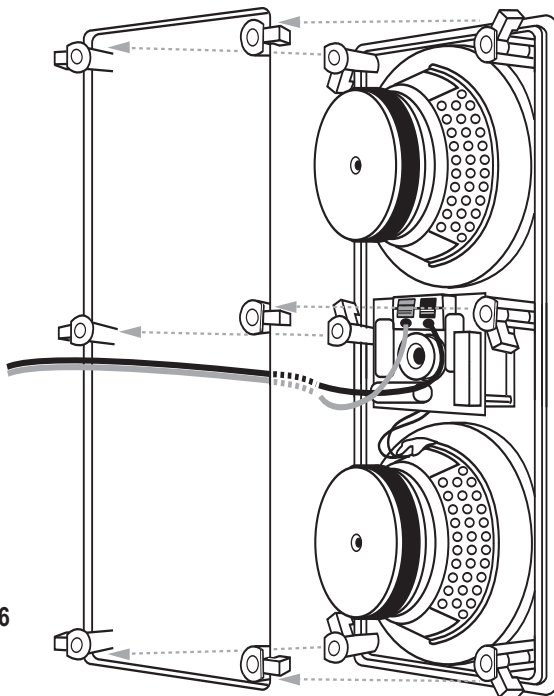

FIG. 6

New Construction

1. Determine speaker locations and mark them on your plans for future reference.
2. If possible, run speaker wires after HVAC and electrical wiring is in place.
3. Secure speaker wires in place along the run with insulated staples only and be careful not to pierce the wire's insulation. Allow a bit of slack for expansion of building materials.
4. The actual speakers should not be installed until the wall board is in place. In the meantime, leave several feet of wire coiled up and secured at the back side of the mounting hole.
5. To complete the installation follow steps 2 through 5 above.

Operational Check

After making all connections it's a good idea to make sure everything is working properly. Turn on your stereo system making sure the volume control is turned down and that the balance control is in the center position. Activate a musical source such as FM, a CD or DVD player. Gently turn up the volume. You should hear music coming from your new NXG speakers. If no sound is heard from any or all speakers, switch off the system immediately and check for open or loose connections, wrong polarity or shorts.

NX-W5.2-LCR-P Specifications

Tweeter: 1" (25mm) minimum-diffraction, pivoting, fluid-cooled high tenacity teteron dome

Woofers: Dual magnetically-shielded 5¼" (133mm) metallic anodized, graphite-filled, injection-molded RCT cones with rubber surrounds

Crossover: Optimized 12dB Electro Acoustic w/mylar capacitors, air core inductors, and gold-plated input terminals

Frequency Response: 45 Hz-22,000 Hz

Impedance: 8 ohms nominal, 6 ohms minimum

Power Handling: 5-120 watts

Sensitivity: 89dB @ 1 watt/1 meter

Grille: Corrosion-resistant, powder-coated aluminum

Overall Dimensions (H x W x D): 7⁵/₈" x 15" x 3¹/₂"
(194 mm x 381 mm x 89 mm)

Cutout Dimensions (H x W): 6³/₈" x 13¹/₈"
(162 mm x 352 mm)

NXG Speakers Three-Year Limited Warranty

If the NXG speaker system proves to be defective in workmanship or materials within three years from the date of the original customer's purchase, we will, at our option, repair or replace the defective product.

Limitation of Implied Warranties

Any implied warranties, including warranties of merchantability and fitness for a particular purpose, are limited in duration to the length of this warranty.

Exclusion of Certain Damages

NXG's liability for any defective product is limited to repair or replacement of the product at our option. NXG shall not be liable for incidental or consequential damages of any kind or character because of product defects. Some states do not allow limitations on how long an implied warranty lasts and/or do not allow the exclusion or limitation of incidental or consequential damages, so the above limitations and exclusions may not apply.

This Warranty Does Not Cover:

- Damage caused by abuse, accident, misuse, negligence, or improper operation.
- Any product whose serial number has been altered, defaced, or removed.
- Products that have been altered or modified.
- Normal wear and maintenance.
- Damages caused by shipping. (All claims for shipping damage must be made with the carrier.)

Warranty Service

Warranty service must be performed by an authorized service center, usually an NXG speaker systems dealer or its authorized agent. You may obtain a list of authorized service centers by contacting NXG. All warranty repairs must be accompanied by the original bill of sales. No other document is acceptable or is required. This warranty gives you specific legal rights, and you may also have other rights which vary from state to state.

NXG reserves the right to revise speaker system specifications without notice.

NXG
TECHNOLOGY

16648 North 94th Street
Scottsdale, AZ 85260
1-800-733-0008